

Patent No. 4,442,663

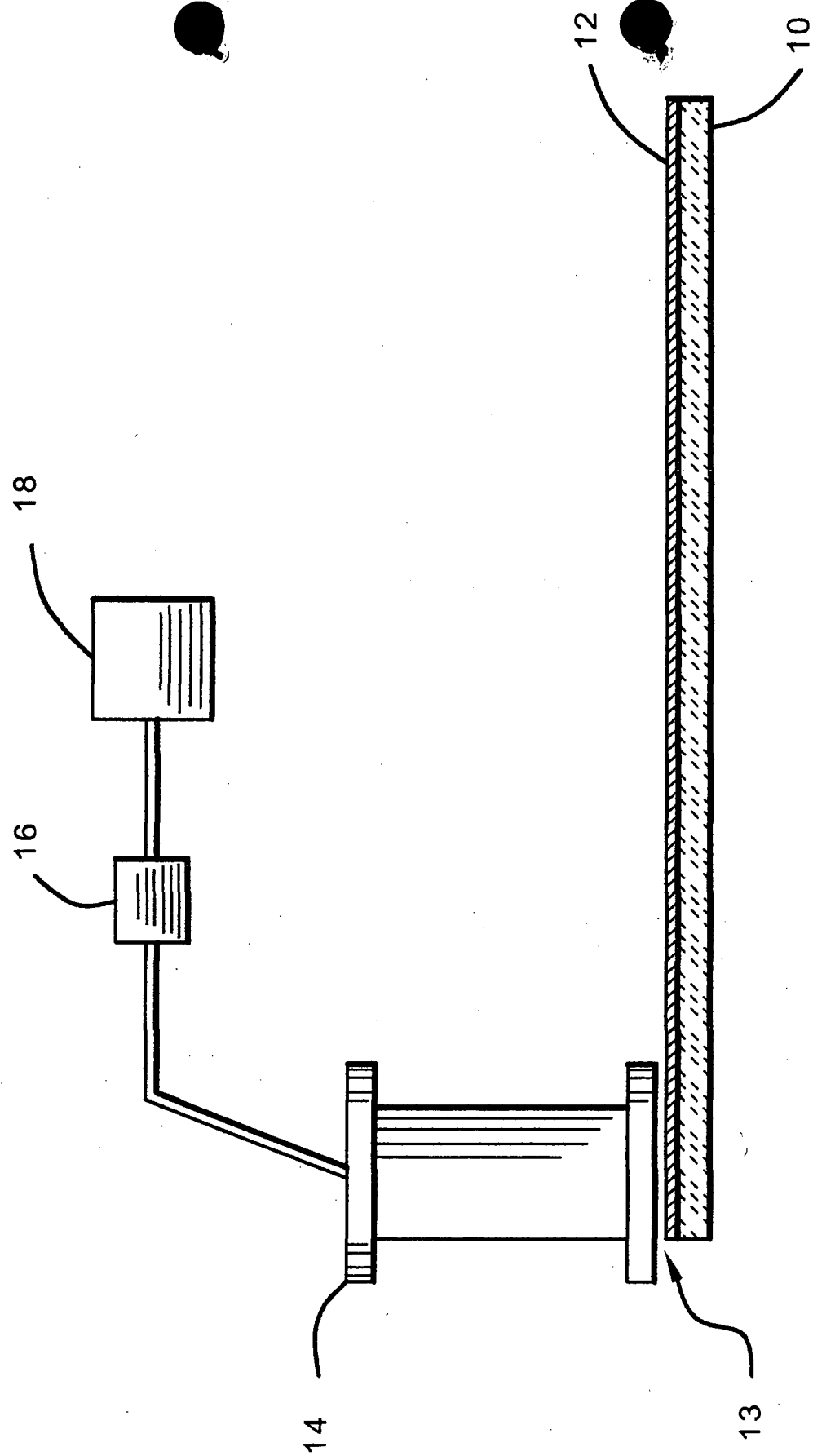

FIG. 1

Patent Application No. 10/200,000

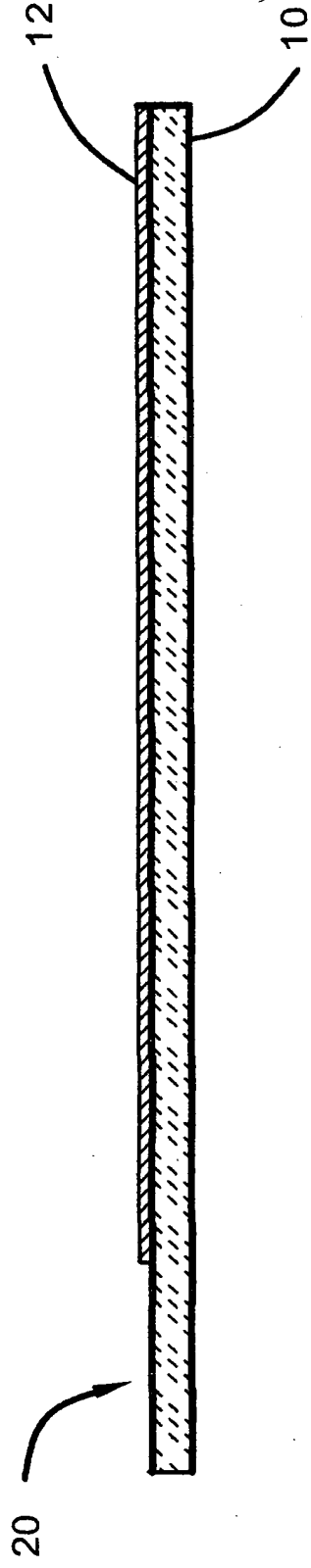

FIG. 2

FIG. 3

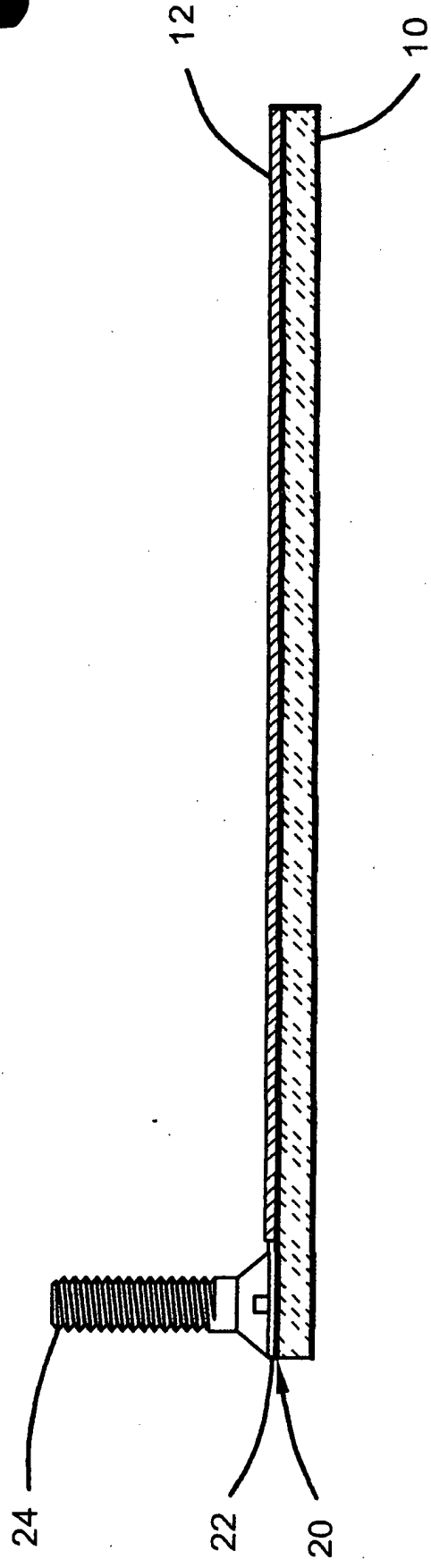

FIG. 3

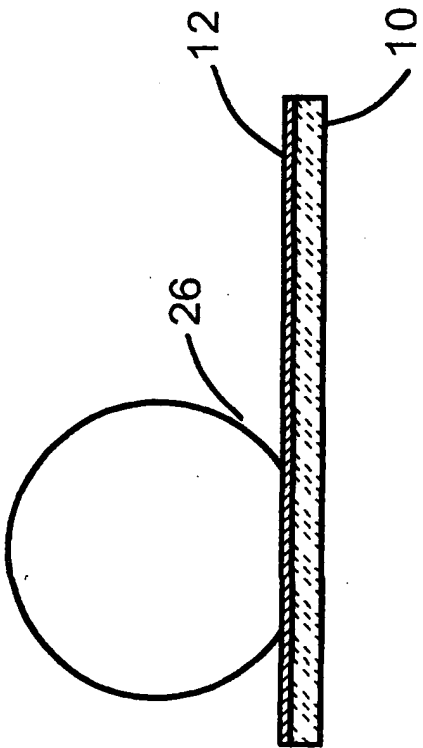

FIG. 4

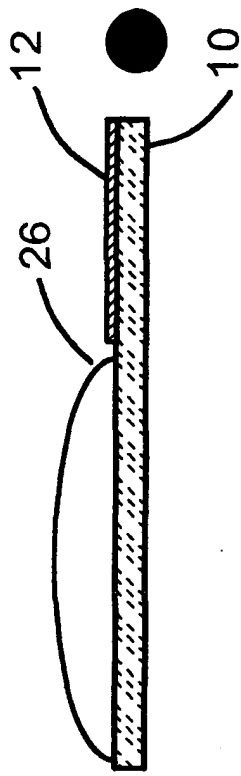

FIG. 5

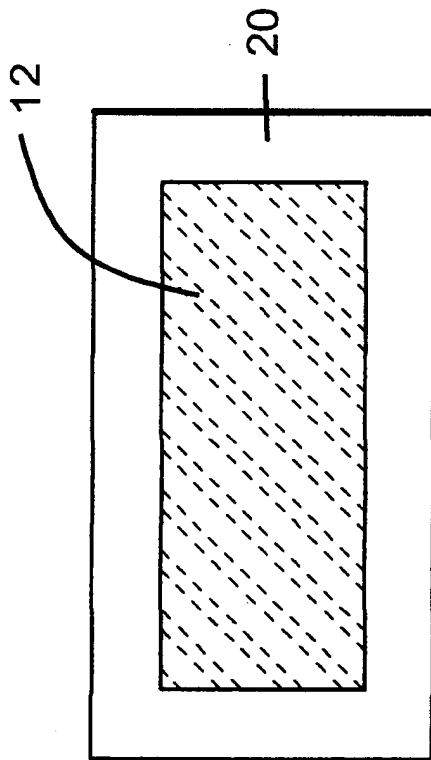

FIG. 6

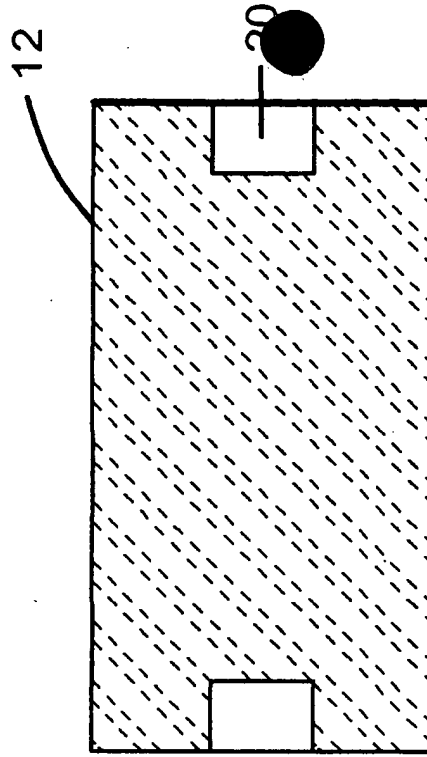

FIG. 7

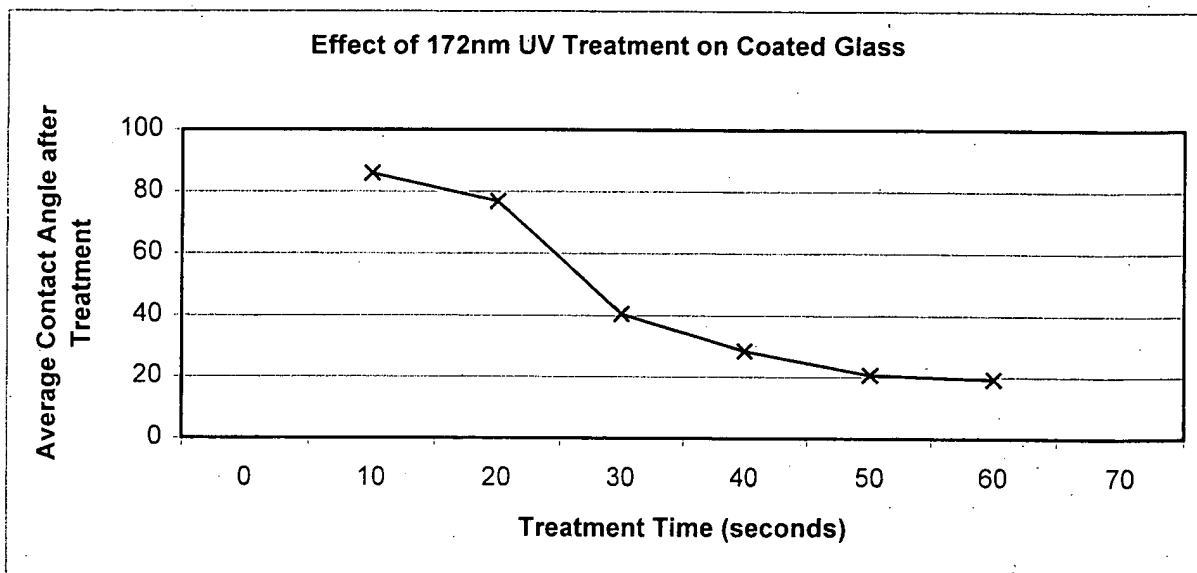

Fig. 8